



OMEGA AIR

Installation and operating manual

Refrigeration Dryer Series

RDP 20 – 2600

RDT 20 – 1900



20240731



Please read the following instructions carefully before installing the product. Trouble free and safe operating of the product can only be guaranteed if recommendations and conditions stated in this manual are respected.



Dear customer!

Thank you for purchasing our product. In order for the product to serve well and reliably, please read these installation and operating instructions carefully.

In order to avoid misuse of equipment and potential hazards for the operator, please read thoroughly and strictly follow the instructions contained in this installation and operating manual.

Before packing and shipping, each unit of the refrigeration air dryers is subjected to rigorous tests to ensure that the factory defects are removed and all the functions of the device for which it was designed checked.

After correctly installing the unit in accordance with the instructions in this manual, it will be ready for use without the need for additional settings. The operation is fully automated, and maintenance is limited to a few checks and cleanings, as shown in the continuation of this manual.

These instructions must always be present at the unit and be available for the entire operating life of the device. The instructions are considered as an integral part of each refrigeration air dryer.

This manual provides the user, installer and maintenance technician with all the technical information needed to install, operate and perform routine maintenance work to ensure long service life. If spare parts are required, they must be original. Requests for SPARE PARTS and any information relating to the unit must be sent to the distributor or to the nearest service center, indicating the MODEL and SERIAL NUMBER located on the data plate of the device.

Due to uninterrupted technical development, we reserve the right to introduce the necessary changes without prior notice. If you need further explanation or clarification, contact the manufacturer or distributor of the device.

Table of Contents

1. GENERAL INFORMATION	5
1.1. Device information	5
1.2. Information on the supplier	5
1.3. Refrigeration air dryers	6
1.4. Proper use	6
1.5. Efficiency	6
1.6. Data plate	7
2. SAFETY INSTRUCTIONS	7
2.1. Safety symbols and signal words used	8
2.2. General safety instructions	9
3. TECHNICAL SPECIFICATIONS	11
3.1. Components	11
3.2. Specifications	11
3.3. Standard parameters and correction factors	13
4. REFRIGERATION AIR DRYER OPERATION	14
5. REFRIGERATION AIR DRYER COMPONENTS	15
5.1. Compressor	15
5.2. Condenser	15
5.3. Heat exchanger 3 in 1	15
5.4. Controller DEK 250	16
OPERATION AND DISPLAY	17
LEDS	17
ALARMS	18
REMOTE ON/OFF	18
MODBUS COMMUNICATION	19
ALARM OUTPUT	19
PROGRAMMING AND PARAMETERS	19
5.5. Controller RDC 4.0	21
LEDS	22
OPERATION AND DISPLAY	23
ALARMS	24
REMOTE ON/OFF	24

MODBUS COMMUNICATION	25
ALARM OUTPUT	25
PROGRAMMING AND PARAMETERS	25
5.6. Condensate drain	27
ELECTRONIC CONDENSATE DRAIN (RDP 20 -1900)	27
TIMER CONTROLLED CONDENSATE DRAIN (RDT)	28
AUTOMATIC MECHANICAL CONDENSATE DRAIN (RDP 2600)	28
5.7. Safety functions	28
5.8. Filter / dehydrator	29
5.9. Capillary tube	29
5.10. Hot gas bypass valve	29
5.11. Pressure switch (RDP/T 600 – 2600)	30
5.12. Isolating transformer (3 phase units without neutral)	30
6. TRANSPORT	31
7. STORING / REMOVE FROM USE	31
8. INSTALLATION	32
8.1. General environment requirements	32
8.2. Compressed air quality and connection	32
8.3. Electrical connection	33
8.4. Installation arrangement	34
8.4. Installation procedure	35
9. START-UP AND SHUT DOWN	36
9.1. Before start-up	36
9.2. Start-up	36
9.3. Shut down	36
10. MAINTENANCE	37
11. DISMANTLING / DISPOSAL OF THE DRYER	37
12. TROUBLESHOOTING	38
13. WARRANTY	41
14. SPARE PARTS	42
15. DRAWINGS	42
16. ELECTRIC DIAGRAM	42
17. MAINTENANCE NOTES	43

1. GENERAL INFORMATION

1.1. Device information

Data plate is located on the back of the device (Figure 1). It contains important data regarding the model, serial number, working conditions and refrigerant used. Always refer to this data when contacting the manufacturer or sales representative.

Model of refrigeration air dryer:

Serial number:

Year of manufacture:

Date of installation:

Please fill in the fields carefully. Correct data enables proper and efficient maintenance of the device, selection of suitable spare parts and technical support.

1.2. Information on the supplier

Name:

Address:

Phone / Fax:

e-mail:

1.3. Refrigeration air dryers

Compressed air contains contaminants such as water, oil and particles. Impurities need to be removed or their concentration reduced to an acceptable level according to the requirements of the application. The ISO 8573-1 standard specifies the purity / quality of the air for contaminants. The humidity (water vapor content) can be expressed in terms of Pressure Dew Point (PDP). Dew point is the temperature at which the air is 100% saturated with moisture. When the air temperature falls below the dew point, moisture condenses. Reduction of moisture content to the point of dew point +3°C can be achieved by refrigeration air dryers.

Refrigeration air dryers are the best choice in all standard applications, where pressure dew point 3 - 10° C suffices. Examples of such applications are process air in the processing industry (pneumatic equipment, wood industry, paint shop, chemical industry, pharmacy, etc.).

1.4. Proper use

⚠ Refrigeration air dryers are designed for efficient and quality separation of the moisture from the compressed air. This device must only be used for the purposes for which it was designed. All other uses of the device are considered incorrect.

⚠ Only use genuine spare parts. Warranty cannot be claimed for damage or malfunction of the device caused by the use of non-original parts.

⚠ Proper use also includes the compliance with the installation instructions. Special attention must be paid to:

- The voltage and frequency of the main voltage supply line.
- The flow rate, pressure and temperature of the inlet compressed air.
- The ambient temperature.

⚠ The manufacturer is not liable under any circumstances for damage resulting from improper, incorrect or unreasonable use or/and installation of the device.

1.5. Efficiency

The efficiency of the refrigeration air dryer and the desired pressure dew point temperature depends mainly on the right sizing of the drier. To ensure efficient operation, the refrigeration air dryers are available in a large number of sizes and operating conditions.

1.6. Data plate

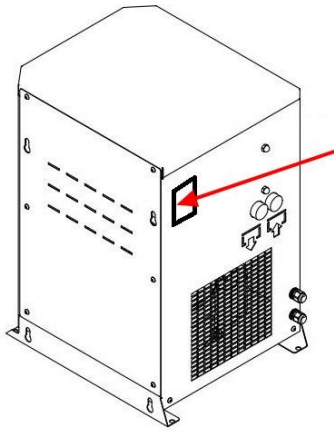

Figure 1 Location of the data plate

Data plate contains important information of the device. It is located on the back of the dryer. It is important to provide the information on the data plate when contacting your sales representative or manufacturer.

Information on the data plate includes but is not limited to:

- Type and model of the dryer
- Main supply line voltage and frequency
- Maximum pressure, temperature and flow rate of the inlet air.
- Type and quantity of the refrigerant used.
- Operating ambient temperature
- Serial number of the dryer

Operation of the dryer must always be within the limits indicated on the data plate. Any deviation can cause serious injury or/and breakdown of the dryer.



The dryer must be equipped with the data plate for the lifetime of equipment. Missing data plate will cause all warranties and claims void.

2. Safety instructions



Please check this manual corresponds to your device.

Please read the following instructions carefully before installing, operating and maintain the product. Trouble free and safe operating of the product can only be guaranteed if recommendations and conditions stated in this manual are respected.

These instructions must always be present at the unit and be available for the entire operating lifetime of the device. The instructions are considered as an integral part of each refrigeration air dryer.

The dryer must be installed and operate under parameters written on the data plate. Operating outside these parameters can cause serious injury and/or equipment damage. Check that all equipment is sized and selected properly.

In case you have any questions regarding this installation and operating manual please contact manufacturer or your sales representative.

2.1. Safety symbols and signal words used



Operating instructions must be observed



General hazard



High voltage hazard



Hot surface hazard



General requirement



Do not use water to extinguish the fire

Danger!

Imminent hazard

Non observance will result in serious injury or death and/or property damage

Warning!

Potential hazard

Non observance could result in serious injury, death and/or property damage

Caution!

Potential hazard

Non observance may result in minor or moderate injury and/or property damage

Notice!

Relevant general information

Important!

Additional advice, info, hints Consequences of non-observance: disadvantages during operation and maintenance, no danger

2.2. General safety instructions



Danger!

Compressed Air!

- Improper use of the compressed air system can lead to serious injury or death.
- Before working on the dryer ensure the dryer is vented and not under pressure (this also applies the closest components of the compressed air installation around the dryer).
- Never exceed the maximum operating pressure (check the information on the data label).
- The permissible operating temperatures and working pressures for the accessories of the dryer are given in the technical documentation of this accessory. The maximum temperature and pressure of the assembled system is the lowest maximum temperature or pressure of any individual part of the system.
- Never direct the compressed air or condensate drain outlet at persons.

Quickly or suddenly escaping compressed air can cause serious injury or death.



Danger!

High voltage!

- Improper electrical installations can lead to serious injury or death.
- Before performing installation and/or maintenance on the dryer ensure the dryer is turned off and not connected to electrical source.
- Electrical installation must be performed by qualified personnel and comply with all applicable national and local codes.

High voltage can cause electrical shock, serious injury or death.



Warning!

Risk of refrigerant leak!

- The dryer contains fluorinated greenhouse gas/refrigerant
- Installation, repair and maintenance works at the refrigeration system must only be carried out by skilled personnel.
- Please refer to the data plate regarding the type and quantity of refrigerant.
- Prevent the escape of the refrigerant into the atmosphere during installation, maintenance and operation of the dryer.



Caution!

Hot surface hazard!

- Some components inside the dryer can reach surface temperatures of more than 60 °C. All such components are installed inside the dryer housing.
- The housing must be opened only by skilled personnel.



Notice!

Wear suitable protective equipment: ear plugs, safety goggles, safety helmet, safety gloves and safety shoes.



Caution!
Improper use!

- Only use refrigeration air dryers for intended purpose.
- Improper handling (transport, installation, use, maintenance) of a refrigeration air dryer can lead to serious injury or death. The result of improper use may be damage to the device and/or reduced efficiency of the dryer.
- Do not exceed the maximum operating pressure or operating temperature (information on the data label).
- The dried compressed air must not be used for breathing air and for direct contact with food.
- The dryer is not suitable to treat contaminated air or air containing solids.
- Ensure that the refrigeration air dryer is not subject to vibrations or mechanical stress that can cause fatigue and cracking of material.
- Never remove or modify safety devices.



Notice!

- When operating the dryer, you must follow all relevant safety and accident prevention instructions, all regulations and instructions for use. The refrigeration air dryer was developed in accordance with the generally recognized rules of engineering practice.
- Ensure that the installation complies with local legislation
- The user or operator of the refrigeration air dryer must be familiar with the installation, commissioning and operation of the appliance.
- All safety information is intended to ensure your personal safety. If you do not have experience with such systems, contact the manufacturer or local supplier for technical assistance.
- All installation and maintenance work on the refrigeration air dryer must be carried out by a qualified and experienced specialist.
- It is forbidden to make any changes to the refrigeration air dryer.
- Ensure that the refrigeration air dryer is installed in accordance with specifications and without mechanical loads.
- Only use genuine spare parts.
- When transporting the dryer, check and follow the local regulations for lifting and transporting heavy objects.
- In the event of fire, do not use extinguishing water on the dryer and nearby objects.
- Wear suitable protective equipment: ear plugs, safety goggles, safety helmet, safety gloves and safety shoes.



Warning!

In the event of fire, do not use extinguishing water on the dryer and nearby objects.

3. Technical Specifications

3.1. Components

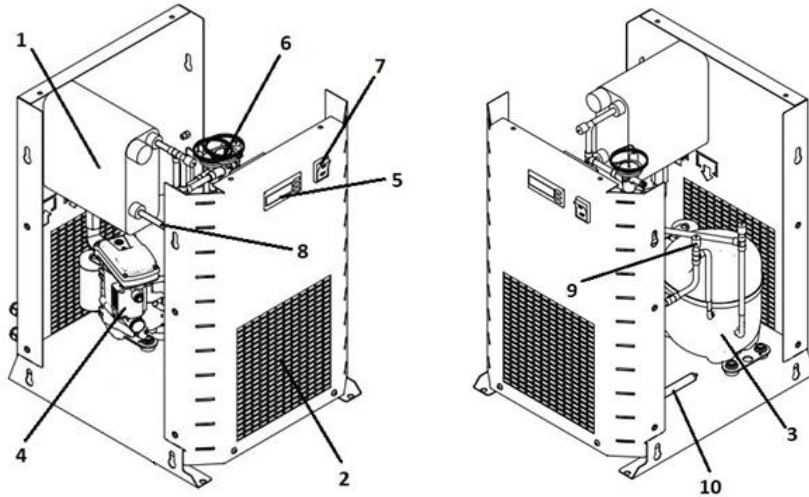

Figure 2 Components

1. Heat exchanger 3 in 1
2. Condenser
3. Compressor
4. Condensate drain
5. Controller

6. Hot gas bypass valve
7. Main power switch
8. Capillary tube
9. Temperature sensor
10. Filter / dehydrator

3.2. Specifications

TECHNICAL SPECIFICATIONS

Max. operating pressure	16 bar _g (RDP 20-1900), 14 bar _g (RDP 2600-13200)
Max. inlet air temperature	55 °C (for temperature ≠ 35 °C apply correction factor)
Operating ambient temperature	1 °C to 45 °C (for temperature > 25 °C apply correction factor)
Storage conditions	1 °C to 65 °C, <90 % relative humidity
Pressure dew point	+ 3 °C
Filter requirement (inlet)	Prefilter 3 µm
Communication	MODBUS
Digital input	Remote ON/OFF
Digital output	Alarm
Condenser type	Air cooled
Max. noise level at 1m	< 65 dbA
Compressor operation	Non-cycling
Condensate drain	Automatic (Zero loss type) (RDP) / Timer controlled (RDT)
Refrigerant	R513a
Protection class (controller front)	IP 65
Handling option	Manual (RDP/T 20-75), Forklift (RDP/T > 100)

MATERIALS

Casing	Carbon steel
Casing corrosion protection	Epoxy powder paint
Evaporator	Brazed plate stainless steel (RDP 600-1900), aluminum (RDP 20-480, RDP 2600)
Evaporator insulation	Flexible elastomeric foam
Condenser	Aluminum fin and copper tube (RDP 20-1900), aluminum MCHE (RDP 2600)
Compressor	Carbon steel
Refrigerant piping	Copper
Controller enclosure	Plastic

SIZES

Model RDP/RDT	Compressed air			Electrical connection		Ambient air		Refrigerant		Dimensions & Mass	
	⁽¹⁾ Flow	Connection	P. drop	Power supply	⁽²⁾ Power/ Consumption	Cooling flow	Heat rejec.	Type	Mass	W x L x H	Net
	m ³ /h		bar	Ph~V~Hz	kW	m ³ /h	kW		kg	mm	kg
20	20	G 3/4" BSP-F	<0,2	1~230-50*	0,160 / 0,135	350	0,2	R513a	0,130	352 x 485 x 592	25
35	35	G 3/4" BSP-F	<0,2	1~230-50*	0,170 / 0,135	350	0,3	R513a	0,130	352 x 485 x 592	25
50	50	G 1" BSP-F	<0,2	1~230-50/230-60	0,20 / 0,18	350	0,4	R513a	0,180	352 x 485 x 592	26
75	75	G 1" BSP-F	<0,2	1~230-50*	0,40 / 0,25	350	0,6	R513a	0,230	352 x 485 x 592	27
100	100	G 1" BSP-F	<0,2	1~230-50/230-60	0,45 / 0,32	350	0,8	R513a	0,260	355 x 550 x 592	32
140	140	G 1" BSP-F	<0,2	1~230-50/230-60	0,50 / 0,38	700	1,1	R513a	0,61	355 x 550 x 592	50
180	180	G 1 1/2" BSP-F	<0,2	1~230-50*	0,60 / 0,45	700	1,5	R513a	0,71	495 x 558 x 826	52
235	235	G 1 1/2" BSP-F	<0,2	1~230-50*	0,73 / 0,60	700	1,9	R513a	0,89	495 x 558 x 826	56
300	300	G 1 1/2" BSP-F	<0,2	1~230-50*	1,0 / 0,7	1100	2,4	R513a	1,07	495 x 558 x 826	84
380	380	G 1 1/2" BSP-F	<0,2	1~230-50/230-60	1,1 / 0,8	1100	3,1	R513a	1,20	495 x 558 x 826	90
480	480	G 1 1/2" BSP-F	<0,2	1~230-50/230-60	1,2 / 1,0	1100	3,9	R513a	1,31	495 x 558 x 826	99
600	600	G 2" BSP-F	<0,2	1~230-50/230-60	1,3 / 1,1	2200	4,9	R513a	1,59	491 x 708 x 973	110
750	750	G 2" BSP-F	<0,2	3~400-50/440-60	2,0 / 1,5	2200	6,1	R513a	2,19	491 x 708 x 973	120
950	950	G 2" BSP-F	<0,2	3~400-50/440-60	2,4 / 1,9	2200	7,7	R513a	2,55	491 x 708 x 973	150
1150	1150	G 2 1/2" BSP-F	<0,2	3~400-50/440-60	2,4 / 2,0	2000	9,4	R513a	3,49	662 x 856 x 1534	250
1300	1300	G 2 1/2" BSP-F	<0,2	3~400-50/440-60	2,6 / 2,3	2000	10,6	R513a	3,25	662 x 856 x 1534	280
1500	1500	G 2 1/2" BSP-F	<0,2	3~400-50/440-60	2,7 / 2,4	4000	12,2	R513a	5,00	662 x 856 x 1534	290
1900	1900	G 2 1/2" BSP-F	<0,2	3~400-50/440-60	3,8 / 3,4	4000	15,5	R513a	5,30	662 x 856 x 1534	310
2600	2600	DN100	<0,2	3~400-50/440-60	8,0 / 3,6	4000	16,1	R513a	11,0	870 x 1502 x 1888	500

⁽¹⁾ Nominal conditions: inlet flow 20 °C at 1 bar_a, ambient 25 °C, dryer inlet 35°C at 7 bar_a, 5 °C pressure dew point (-19,3 °C atmospheric).

⁽²⁾ For 60 Hz 20 % more than stated, consumption at nominal conditions.

* Special 60 Hz version available.



Notice!

Always check the information on the data plate of the dryer!

The data in this table is only informative and can change without notice!

(See chapter: 1.6. Data plate for additional information)

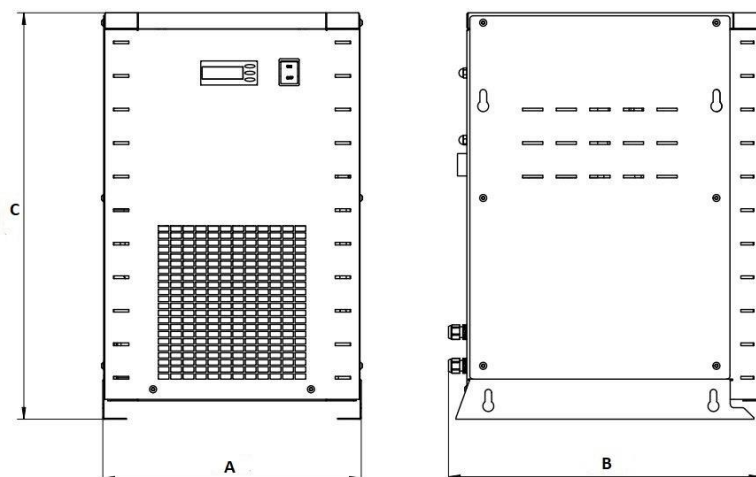

3.3. Standard parameters and correction factors

PERFORMANCE DATA PER ISO 7183:2007

Ambient temperature	25 °C / 77 °F
Inlet relative humidity	100 %

Inlet pressure	7 bar / 102 psig
Inlet temperature	35 °C / 95 °F

To calculate the correct capacity of a given dryer based on actual operating conditions, multiply the nominal inlet flow by the appropriate correction factor(s).

$$\text{CORRECTED CAPACITY} = \text{NOMINAL FLOW CAPACITY} \times C_{OP} \times C_{AT} \times C_{IN} \times C_{DP}$$

OPERATING PRESSURE

[bar]	2	3	4	5	6	7	8	9
[psi]	29	44	58	72	87	100	115	130
C _{OP}	0,39	0,60	0,77	0,86	0,93	1,00	1,05	1,10

[bar]	10	11	12	13	14	15	16
[psi]	145	160	174	189	203	218	232
C _{OP}	1,14	1,18	1,21	1,20	1,27	1,30	1,32

DEW POINT

°C	3	5	7	10
°F	37,4	41	44,6	50
C _{DP}	1,00	1,10	1,21	1,39

INLET TEMPERATURE

[bar]	25	30	35	40	45	50	55
[psi]	77	86	95	104	113	122	131
C _{OP}	1,2	1,12	1	0,83	0,69	0,59	0,5

AMBIENT TEMPERATURE

°C	25	30	35	40	45
°F	77	86	95	104	113
C _{DP}	1	0,96	0,9	0,82	0,72

4. Refrigeration air dryer operation

The refrigeration air dryer is designed to remove moisture from the input air to achieve the desired dew point at the exit.

All refrigeration air dryers described above operate according to the same principle. The operation of the refrigeration air dryer can be divided into two main circuits: Air and refrigeration circuit.

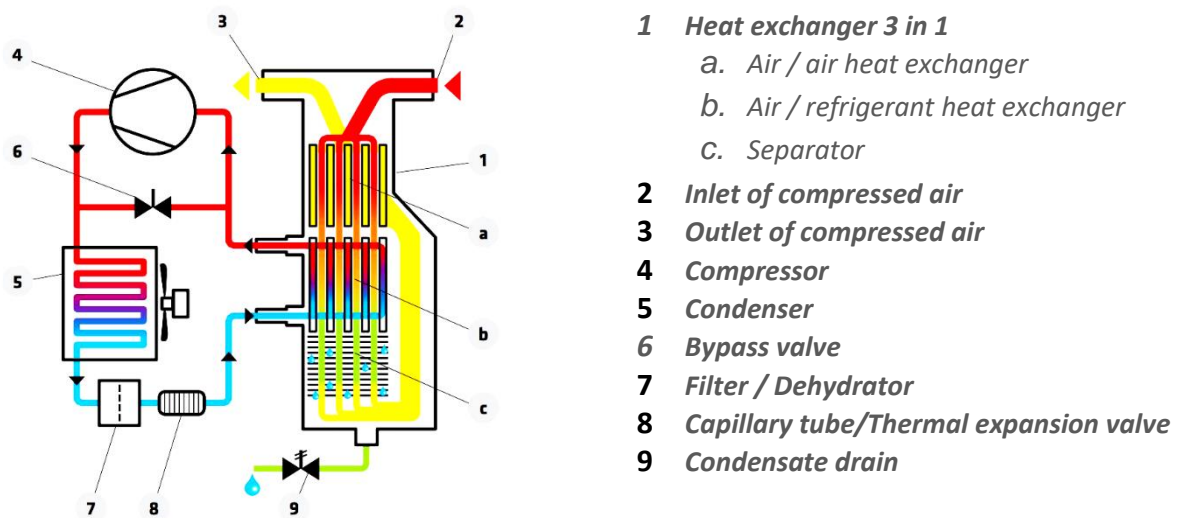

Figure 3 P&ID scheme and main components

Air Circuit: Hot, moisture saturated air enters the 3 in 1 heat exchanger. The air then passes through the evaporator, also called the air / refrigerant heat exchanger. The air temperature is reduced to about 2 °C, which causes condensation of the water vapor. The liquid is merged into larger droplets and collected in a separator, from where the condensate drain removes it from the system. The cool air without liquid water is returned through the air / air heat exchanger, where it is heated to approximately 5 °C lower temperature than the input air.

Refrigeration circuit: The refrigerant enters the compressor and then enters the condenser at high pressure, where it transfers heat to the ambient air and condenses. The liquid then passes through the capillary tube, where its pressure and consequently the temperature decreases. At low pressure, the liquid refrigerant enters the heat exchanger where it receives heat from the inlet compressed air and causes the evaporation of the refrigerant. The low-pressure gaseous refrigerant returns to the compressor, which compresses it and starts the cycle again.

5. Refrigeration air dryer components

5.1. Compressor

The compressor sucks the gaseous phase of the refrigerant from the evaporator (low pressure side) and compresses it to the condensation pressure (high pressure side). Built-in compressors are manufactured by leading manufacturers and are designed for applications where high compression ratios and high temperature differences are present. Hermetically sealed structure is tight and provides high energy efficiency and long service life. The anti-vibration springs that carry the compressor reduce sound emissions and transmission of vibrations. The refrigerant flowing through the compressor to the cylinders of the compressor also cools the electric motor.



Notice!

The compressors are equipped with thermal protection!

Thermal protection protects the compressor against overheating and overcurrent. The protection is automatically reset when normal operating temperature is reached.

5.2. Condenser

The condenser is a component in which the gas coming from the compressor cools, condenses and changes the aggregate state from the gaseous to the liquid. The condenser is a pipe in which the refrigerant is flowing, and on which fins are placed. The heat transfer is accelerated by an efficient fan.



Caution!

- Always ensure that the ambient temperature does not exceed values written on the data plate.
- Keep the condenser clean without dust or other impurities accumulated on it.
- Never obstruct ventilation grilles.

5.3. Heat exchanger 3 in 1

The heat exchanger 3 in 1 combines air / air heat exchanger, air / coolant heat exchanger and condensate separator. The compressed air counterflow in the air / air heat exchanger ensures maximum heat transfer. A large cross-section of the flow channel in the heat exchanger 3in1 provides low speed and low-pressure losses. The large dimensions of the heat exchanger air / refrigerant and the counter-flow design enable the complete evaporation of the refrigerant (preventing the return of the liquid to the compressor). A highly efficient condensate separator is located inside the heat exchanger 3in1. No maintenance required, the effect of collecting drops ensures a high degree of moisture separation.

5.4. Controller DEK 250



Figure 4 Front panel

The controller DEK 250 shows the temperature of the dew point reached by the refrigeration air dryer in the normal operation.

The controller controls the condenser fan based on the thermal load of the dryer (RDP 20-480).



Notice!

- Displayed dew point values between 0 °C and 10 °C are considered correct. This is due to the possible operating conditions (air flow, air inlet temperature, ambient temperature...).
- It is recommended to leave the dryer in working state during short term shut downs of the compressed air flow (2-3 days).

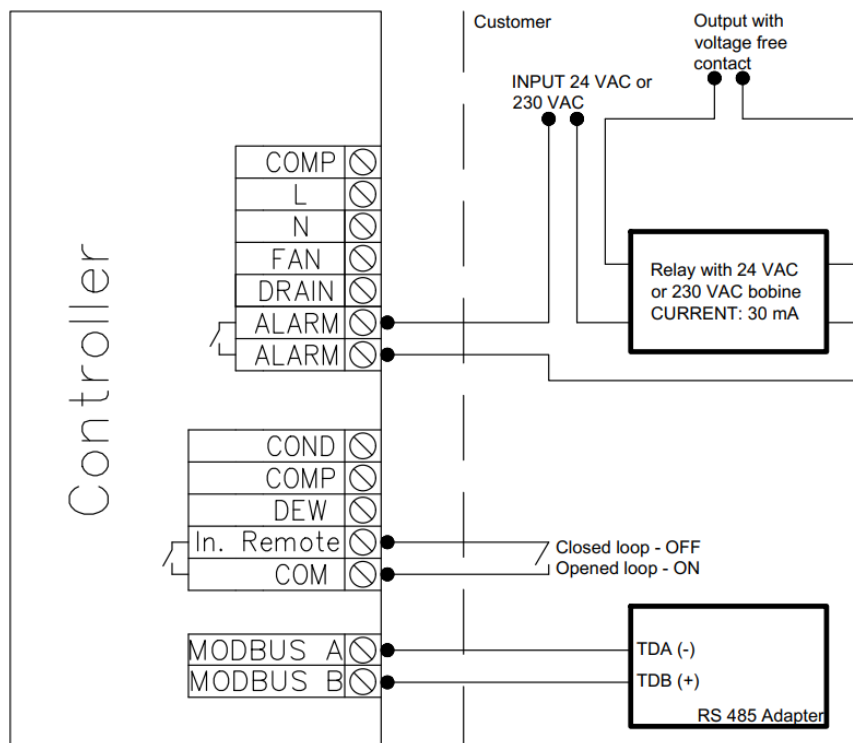



Figure 5 Electric scheme with optional connections



OPERATION AND DISPLAY

OFF

Standby mode:

The dryer is in standby mode. The compressor and fan(s) are off. In case compressor oil heater is installed the heater is on.

Press  +  for 3 seconds to start the dryer.

Press  +  for 3 seconds to load default parameters.

Press  to show firmware release.

Press  for 3 seconds to enter parameter setting mode.



It is recommended to wait at least 2 hours before starting the dryer after the main switch has been turned on.





Make sure not to turn the dryer on and off more than 6 times / hour. This can damage the dryer.



3



Normal operation:

In normal operation the controller shows dew point reached by the dryer. Values between 0 °C and 10 °C are considered normal.

Press  to see the compressor temperature.

Press  to see the condenser temperature.

Press  +  to activate condensate drain (units with timer-controlled condensate drain.)





Press  +  to enter standby mode.

Press  for 5 seconds to enter parameter setting mode.

SEC

SERVICE WARNING

LEDS

LED	STATUS	DESCRIPTION
	OFF	Compressor off
	ON	Compressor on
	BLINKING	Compressor stopped due to time protection
	OFF	Fan off
	ON	Fan on
	BLINKING	No function
	OFF	No function / Condensate drain closed (units with timer-controlled drains)
	ON	No function / Condensate drain open (units with timer-controlled drains)
	BLINKING	No function
	OFF	Normal operation
	ON	Alarm operation - check the display for additional information
	BLINKING	No function

ALARMS

PF 1

Dew point sensor failure.

Permanent alarm. The dryer will not start/work.

PF 2

Compressor temperature sensor failure.

Permanent alarm. The dryer will not start/work.

PF 3

Condenser temperature failure.

Permanent alarm. The dryer will not start/work.

Ht

Compressor temperature ≥ 105 °C. Possible compressor damage.

The dryer will enter in special alarm operation to prevent freezing and damage of the evaporator. Dryer will resume normal operation after the drop of temperature.

Lt

Dew point ≤ -2 °C. Possible freezing.

The dryer will enter in special alarm operation to prevent freezing and damage of the evaporator. Dryer will resume normal operation after the rise of temperature.

CLn

Condensation temperature > 70 °C – refrigerant pressure > 20 bar.

It activates when the condensation temperature is above 70 °C. The dryer will enter in special alarm operation to prevent damage of the dryer. Dryer will resume normal operation after the fall of the condensation temperature.

SEC

Service Warning



Notice!

- If more alarms are activated the last one is displayed.
- If alarm is activated 5 times in 24 hours, the compressor stays OFF, the fan stays OFF and the alarm is displayed until user reset.



For the troubleshooting see chapter 12. Troubleshooting

REMOTE ON/OFF

Controller can also be turned OFF/ON via In. Remote by changing the parameter 13 (Remote control) from 0 to 1. By default, when the circuit is connected, the controller goes to OFF state, when the circuit is disconnected, the controller is in ON state. (See the Figure 5 Electric scheme). This can be changed by parameter 8.



CAUTION!

The dryer is designed to run continuously and should not be cycling on and off with the compressor. Switching the dryer ON and OFF too often can cause damage to the dryer.

MODBUS COMMUNICATION

For MODBUS communication the RS485 adapter is needed. The twisted pair of cables needs to be connected to A and B. The default address for the MODBUS communication is 1. This can be changed through parameter 14.

MODBUS SETTINGS	
BAUD RATE	9600
WORD LENGTH	8
PARITY	NO
STOP BITS	1

Contact the manufacturer / supplier for additional information.

ALARM OUTPUT

Alarm is triggered through opto triac. Connect 24 Vac or 240 Vac / 30 mA. For the connection see Figure 5 Electric scheme with optional connections

PROGRAMMING AND PARAMETERS

- To enter the settings menu, press **SET** for 3 seconds.
- Press **▲** or **▼** to change value.
- Press **SET** to confirm / move to next.
- The pass code to enter programming menu is "000"
- The controller will display "Pn" and the set value. Where the "n" means parameter number.









Example:

Procedure to change the minimal compressor OFF time:

- Hold **SET** button for 3 seconds.
- Enter password (000) (press **SET** 3 times).
- Continue pressing **SET** button until you reach parameter number 5.
- You will see the default parameter value (5 min). Change it to a desired value, if necessary, if not skip the next step.
- Wait a couple of seconds, the controller saves the parameters and exits programming mode automatically.

Turn off the dryer and then turn it back on.

Every other parameter can be changed by similar procedure. Differences are in parameter number and in parameter value.





Pn parameter number	Function	Press 	Press 	Press 	Default	Range	Increment
1	Drain Cycle Value	Go to following parameter	Increase value	Decrease value	1	1 – 10 s	1 s
2	Drain Period Value	Go to following parameter	Increase value	Decrease value	200	0 - 600 s	60 s
3	Do not change	Go to following parameter	Increase value	Decrease value	0		
4	Do not change	Go to following parameter	Increase value	Decrease value	5		
5	Min Compressor OFF time	Go to following parameter	Increase value	Decrease value	1	0 – 10 min	1 min
6	Do not change	Go to following parameter	Increase value	Decrease value	2		
7	Do not change	Go to following parameter	Increase value	Decrease value	5		
8	Do not change	Go to following parameter	Increase value	Decrease value	0		
9	Do not change	Go to following parameter	Increase value	Decrease value	0		
10	Do not change	Go to following parameter	Increase value	Decrease value	0		
11	Do not change	Go to following parameter	Increase value	Decrease value	40		
12	Do not change	Go to following parameter	Increase value	Decrease value	40		
13	Remote Control	Go to following parameter	Increase value	Decrease value	0	0 = local 1 = remote	
14	MOD BUS Address	Go to following parameter	Increase value	Decrease value	1	0 - 31	1
15	Service Time	Go to following parameter	Increase value	Decrease value	365	0 – 1000 0 = disable	1
16	Alarms occurred in last 24 hours	Go to following parameter	No action	No action	 &  together resets values		
17	Alarms occurred since service	Go to following parameter	No action	No action	 &  together resets values		
18	Day to next Service	Go to Parameter 1	No action	No action	 &  together resets values		



Notice!

Setting the parameters to wrong values can cause the dryer to not work properly or even damage of the dryer!

The default parameters can be restored:

1. Press  +  for 3 seconds to enter standby mode.
2. Press  +  for 3 seconds to load default parameters.
3. Press  to confirm.

5.5. Controller RDC 4.0



Figure 6 Front panel

The controller RDC 4.0 shows “Dry” when the dew point is within the limits and “HdP” when the dew point is outside of the limits.

Press **SET** to see dew point reached in °C or °F – based on parameter11 in settings.





The controller controls the condenser fan based on the thermal load of the dryer (RDP 20-480).



Notice!

- Displayed dew point values between 0 °C and 10 °C are considered correct. This is due to the possible operating conditions (air flow, air inlet temperature, ambient temperature...).
- “HdP” displayed on the dryer is not considered as alarm. It means the dryers has not reached requested dew point.
- It is recommended to leave the dryer in working state during short term shut downs of the compressed air flow (2-3 days).

LEDS

LED	STATUS	DESCRIPTION
	OFF	Compressor off
	ON	Compressor on
	BLINKING	Compressor stopped due to time protection
	OFF	Fan off
	ON	Fan on
	BLINKING	No function
	OFF	No function / Condensate drain closed (units with timer-controlled drains)
	ON	No function / Condensate drain open (units with timer-controlled drains)
	BLINKING	No function
	OFF	Normal operation
	ON	Alarm operation - check the display for additional information
	BLINKING	No function

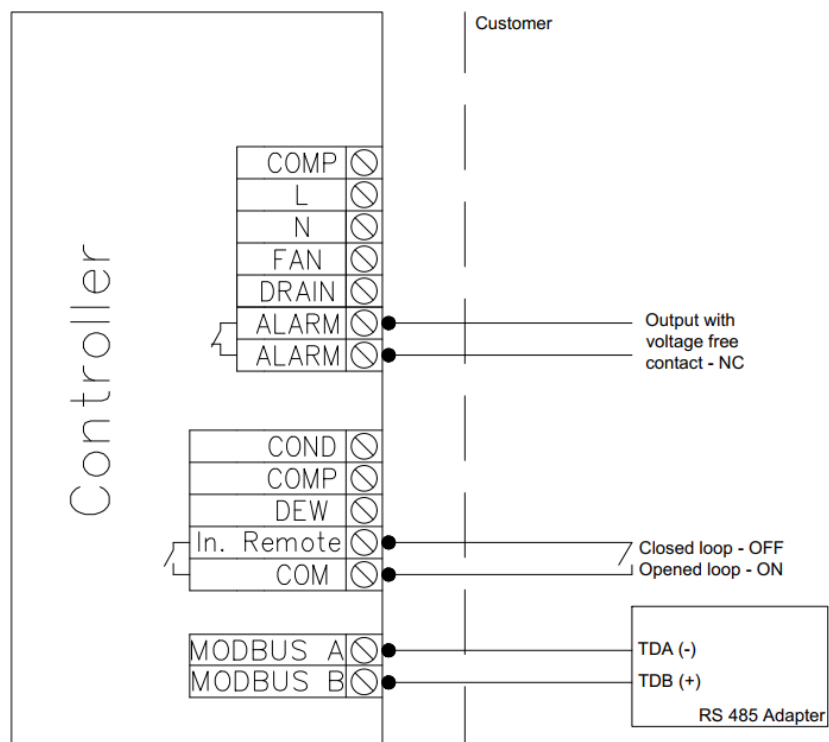



Figure 7 Electric scheme with optional connections



OPERATION AND DISPLAY



Standby mode:

The dryer is in standby mode. The compressor and fan(s) are off. In case compressor oil heater is installed the heater is on.

Press  +  for 3 seconds to start the dryer.

Press  +  for 3 seconds to load default parameters.

Press  to show firmware release.

Press  for 10 seconds to enter parameter setting mode.



It is recommended to wait at least 2 hours before starting the dryer after the main switch has been turned on.



Make sure not to turn the dryer on and off more than 6 times / hour. This can damage the dryer.





Normal operation:



In normal operation the controller shows “dry”. It means the controller is in normal operation mode and the dew point reached is within requested limits.

Press  to see the dew point reached.

Press  to see the compressor temperature.

Press  to see the condenser temperature.

Press  +  to activate condensate drain (RDT units)

Press  +  to enter standby mode.

Press  for 10 seconds to enter parameter setting mode.





Normal operation:



In normal operation the controller shows “HdP”. It means the controller is in normal operation mode and the dew point reached is outside requested limits.

Press  to see the dew point reached.

Press  to see the compressor temperature.

Press  to see the condenser temperature.

Press  +  to activate condensate drain (RDT units)

Press  +  to enter standby mode.

Press  for 10 seconds to enter parameter setting mode.



“HdP” **blinking** – permanent alarm. The dryer cannot reach desired dew point. Dryer is stopped.



SERVICE WARNING

Service time is due. Contact your supplier / service to check the dryer.

ALARMS

PF 1

Dew point sensor failure.

Permanent alarm. The dryer will not start/work.

PF 2

Compressor temperature sensor failure.

Permanent alarm. The dryer will not start/work.

PF 3

Condenser temperature failure.

Permanent alarm. The dryer will not start/work.

Ht

Compressor temperature ≥ 105 °C. Possible compressor damage.

The dryer will enter in special alarm operation to prevent freezing and damage of the evaporator. Dryer will resume normal operation after the drop of temperature. "Ht" **blinking** – permanent alarm. The dryer will not start/work.

Lt

Dew point ≤ -2 °C. Possible freezing.

The dryer will enter in special alarm operation to prevent freezing and damage of the evaporator. Dryer will resume normal operation after the rise of temperature. "Lt" **blinking** – permanent alarm. The dryer will not start/work.

CLn

Condensation temperature > 70 °C – refrigerant pressure > 20 bar.

It activates when the condensation temperature is above 70 °C. The dryer will enter in special alarm operation to prevent damage of the dryer. Dryer will resume normal operation after the fall of the condensation temperature.

"CLn" **blinking** – permanent alarm. The dryer will not start/work.



Notice!

- If more alarms are activated the last one is displayed.
- If alarm is activated 5 times in 24 hours, the compressor stays OFF, the fan stays OFF and the alarm is displayed until user reset.



For the troubleshooting see chapter 12. Troubleshooting

REMOTE ON/OFF

Controller can also be turned OFF/ON via In. Remote by changing the parameter 13 (Remote control) from 0 to 1. By default, when the circuit is connected, the controller goes to OFF state, when the circuit is disconnected, the controller is in ON state. (See the Figure 5 Electric scheme). This can be changed by parameter 8.



CAUTION!

The dryer is designed to run continuously and should not be cycling on and off with the compressor. Switching the dryer ON and OFF too often can cause damage to the dryer.

MODBUS COMMUNICATION

For MODBUS communication the RS485 adapter is needed. The twisted pair of cables needs to be connected to A and B. The default address for the MODBUS communication is 1. This can be changed through parameter 14.

MODBUS SETTINGS	
BAUD RATE	9600
WORD LENGTH	8
PARITY	NO
STOP BITS	1

Contact the manufacturer / supplier for additional information.

ALARM OUTPUT

Relay is provided to trigger alarm output.



Warning!

Maximum load current 1 A

Maximum load voltage: 30 VDC / 250 VAC

PROGRAMMING AND PARAMETERS

- To enter the settings menu, press **SET** for 3 seconds.
- Press **▲** or **▼** to change value.
- Press **SET** to confirm / move to next.
- The pass code to enter programming menu is "000"
- The controller will display "Pn" and the set value. Where the "n" means parameter number.

Example:

Procedure to change the minimal compressor OFF time:

- Hold **SET** button for 3 seconds.
- Enter password (321).
- Continue pressing **SET** button until you reach parameter number 5.
- You will see the default parameter value (5 min). Change it to a desired value, if necessary, if not skip the next step.
- Wait a couple of seconds, the controller saves the parameters and exits programming mode automatically.

Turn off the dryer and then turn it back on.



Every other parameter can be changed by similar procedure. Differences are in parameter number and in parameter value.

Pn parameter number	Function	Press SET	Press 	Press 	Default	Range
1	Drain Cycle Value	Go to following parameter	Increase value	Decrease value	1	1 – 10 s
2	Drain Period Value	Go to following parameter	Increase value	Decrease value	200	0 - 600 s
3	Do not change	Go to following parameter	Increase value	Decrease value	0	
4	Do not change	Go to following parameter	Increase value	Decrease value	5	
5	Min Compressor OFF time	Go to following parameter	Increase value	Decrease value	5	0 – 10 min
6	Do not change	Go to following parameter	Increase value	Decrease value	2	
7	Do not change	Go to following parameter	Increase value	Decrease value	5	
8	Do not change	Go to following parameter	Increase value	Decrease value	1	
9	Do not change	Go to following parameter	Increase value	Decrease value	1	
10	Display mode	Go to following parameter	Increase value	Decrease value	3	0 – temperature 1 – Do not use 2 – Do not use 3 – “Dry”/”HdP 4 – Do not use 5 – Do not use
11	Display unin	Go to following parameter	Increase value	Decrease value	0	0 - °C 1 - °F
12	Do not change	Go to following parameter	Increase value	Decrease value	0	
13	Do not chane	Go to following parameter	Increase value	Decrease value	0	
14	Do not chane	Go to following parameter	Increase value	Decrease value	0	
15	Do not change	Go to following parameter	Increase value	Decrease value	40	
16	Do not change	Go to following parameter	Increase value	Decrease value	40	
17	Remote control	Go to following parameter	Increase value	Decrease value	0	0 - local 1- remote
18	MOD BUS Address	Go to following parameter	Increase value	Decrease value	1	0 - 31
19	Do not change	Go to following parameter	Increase value	Decrease value	365	
20	Alarms occurred in last 24 hours	Go to following parameter	No action	No action	SET &  2 s together resets values	
21	Alarms occurred since service	Go to following parameter	No action	No action	SET &  2 s together resets values	
22	Days missing to service	Go to Parameter 1	No action	No action	SET &  2 s together resets values	



Notice!

Setting the parameters to wrong values can cause the dryer to not work properly or even damage of the dryer! The default parameters can be restored:

1. Press  + **SET** to enter standby mode.
2. Press  +  for 3 seconds to load default parameters.
3. Press **SET** to confirm

5.6. Condensate drain



Caution!



Compressed air

Before performing any maintenance on the drain ensure the dryer is vented and not under pressure.

ELECTRONIC CONDENSATE DRAIN (RDP 20 -1900)

Electronically controlled condensed water drain that discharges water trapped in the lowest parts of compressed air installation out of the system. It consists of a water tank, valve assembly and electronics. In the tank, there is a water level sensor. This way, electronics could detect the tank is full. Then, it operates the electromagnetic valve to discharge condensed water from compressed air system. Another part of the valve assembly is a strainer where solid parts of debris are intercepted. The strainer is located in front of EMD12 so that it could be reached easily. Because of its construction, it can be attached to the compressed air system horizontally or vertically.

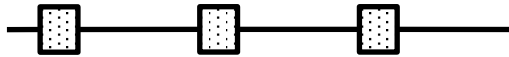
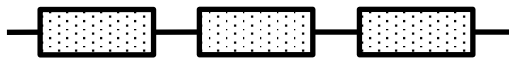
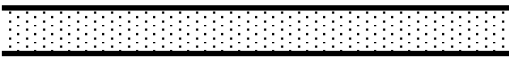
The mode of operation is a water level triggered discharging. The valve opens when water level in tank reaches threshold and it closes back before the tank is empty. This way, only condensed water is discharged and no compressed air is lost.

	<p>By pressing the test button, valve is opened.</p> <p>Green LED indicator shows water level in tank. Short green flashes show that water in tank is under the threshold.</p>  <p>Long green flashes indicate that the tank is almost full.</p>  <p>When the tank is full, the green is on permanently.</p>  <p>Red LED indicator is on permanently during alarm mode.</p> 
--	--

Contact your supplier for the detailed manual for electronic condensate drain.







Notice!

It is recommended to clean/change the strainer every six months or more often, depending on application. Sealing elements are subject to wear, which depends on various operating parameters such as pressure, temperature, dirt content, etc. It is also recommended to change sealing elements.

TIMER CONTROLLED CONDENSATE DRAIN (RDT)

Condensate drain consists of two timers, T_{on} and T_{off} which are regulated by controller (P1 and P2) the dryer controller. T_{on} timer regulates the time duration of discharging and T_{off} regulates time between two discharges (period). When the controller sends a signal at pin DRAIN, it activates the discharging process immediately, which is noticed by the sound of valve being open. Condensate flows through inlet connection and is discharged through valve and outlet connection. After the set time T_{on} passes, valve closes until the time T_{off} passes, when new cycle begins. Cycles are continuously repeating.

Press  +  or  +  to manually activate condensate drain.



Notice!

It is recommended to clean/change the strainer every six months or more often, depending on application. Sealing elements are subject to wear, which depends on various operating parameters such as pressure, temperature, dirt content, etc. It is also recommended to change sealing elements.

AUTOMATIC MECHANICAL CONDENSATE DRAIN (RDP 2600)

Automatic mechanical condensate drain has been developed for fully automatic discharging of condensate from the compressed air system. Condensate accumulates in reservoir and when the level is high enough condensate is being discharged from the system without any compressed air loss. Direct acting valve is operated by precise level-controlled floater which assures reliable and efficient operation.

Once per year make a visual check of the drain and make sure there is no visual damage or leakage. Clean interior of the reservoir regularly. Intervals of cleaning depend on contamination of condensate. Replace the sealings if necessary.



Important!

Condensate from compressed air contains oils and other impurities.

It is strongly recommended that waste condensate from discharge port is connected to water treatment application, such as WOSm series water oil separator to protect the environment from pollution and to comply with environmental laws.

5.7. Safety functions

Safety functions are implemented in the controller. See chapter 5.4. Controller For the protection against low and high pressure the high- and low-pressure switches are added (RDP/T 750 – 2600)

LPS: Low-pressure protection device on the suction side of the compressor trips, if the pressure drops below the pre-set value. The valve is automatically reset when the nominal conditions are restored.

Calibrated pressure: Stop 0.7 bar(g) - Restart 1.7 bar(g)

HPS: High-pressure protection device trips, if the pressure exceeds the pre-set value. The values need to be manually reset when the nominal conditions are restored by pressing the red rubber button.

Calibrated pressure: Stop 26 bar(g) – Manual restart < 21 bar(g)

5.8. Filter / dehydrator

Moisture and impurities can be present in the refrigeration circuit. This can reduce the lubrication of the compressor and block the expansion valve or capillary tube. The dryer filter / dehydrator is located in front of the capillary tube to remove moisture and impurities from the circulation system.

5.9. Capillary tube

The capillary tube is located between the condenser and the evaporator and functions as a metering device for reducing the pressure of the refrigerant. The pressure reduction is a design-based function. The length and inner diameter of the capillary tube are precisely dimensioned, ensuring good performance in all designed conditions.

5.10. Hot gas bypass valve

This valve works as capacity regulator. It adapts compressor capacity to actual evaporator load maintaining a constant temperature / pressure of the evaporator at about +2 °C. Fitted between the high- and low-pressure sides of the air-dryer refrigerant system maintain constant compressor suction pressure by injecting hot gas from the high-pressure side.

This prevents the formation of ice in the evaporator of the dryer under any load conditions.

The bulb only serves as a reservoir for the charge. It is recommended that the bulb is mounted in a location where the temperature variation is limited.

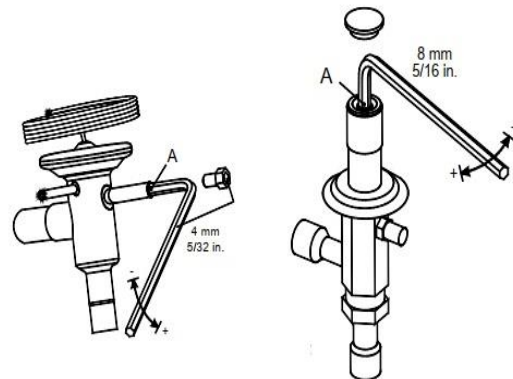

SETTING

The hot gas bypass valve is factory preset during the test phase. No additional settings are needed, but if an intervention is required, a qualified cooler technology engineer should adjust it.

The screw needs to be adjusted without the load on the dryer. Rotate the screw until the following value is reached:

Refrigerant	Suction pressure
R513a	2,3 ±0,1 bar
R134a	2,0 ±0,1 bar



Caution!

Compressed air

Before performing any maintenance on the drain ensure the dryer is vented and not under pressure.

5.11. Pressure switch (RDP/T 600 – 2600)

Pressure switches are for use in refrigeration and air conditioning systems to give protection against excessively low suction pressure or excessively high discharge pressure.

They are used for starting and stopping fans on air-cooled condensers.

The pressure switches come preset to correct values when supplied by manufacturer / your supplier.

Settings:

Turn on: 11,5 bar

Turn off: 8,5 bar



5.12. Isolating transformer (3 phase units without neutral)

Isolating transformer is used to provide 1 phase power for the controller and fan(s) in 3 phase units without neutral. It can be used for different input voltages. By default, it is connected based on the information on the data label on the back of the dryer. Type of the transformer can vary.

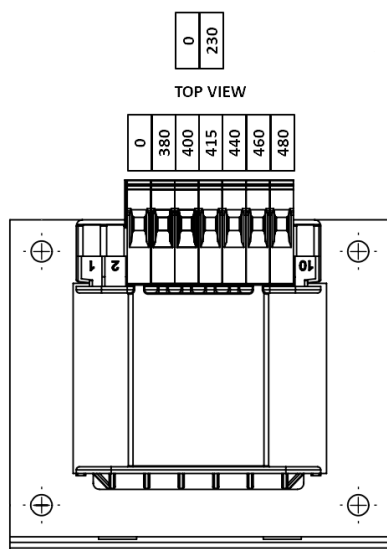

WIRING DIAGRAM

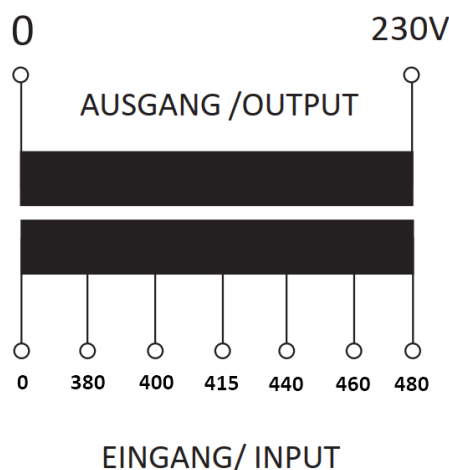

Danger!

High voltage!

- Changing the input voltage must be performed by qualified electrician and comply with all applicable national and local codes.
- Wrong voltage connection can cause the damage of the dryer.

High voltage can cause electrical shock, serious injury or death.

6. Transport

- Check the packaging and dryer for any visible damage. The refrigeration dryer can be damaged during transport. Operating such dryer may result in injury or death. In case of visual damage report the damage to the delivery carrier and contact manufacturer/supplier.
- Always transport the dryer in the upright condition. The components may become damaged when unit is tilted.
- Avoid rough handling. Hard impacts can cause damage to the dryer.
- Transport must be carried out by trained personnel.
- Follow local regulations for lifting and transporting heavy loads.
- Provide adequate lifting and transport equipment.
- A forklift can be used to lift the refrigeration air dryer.



Warning!
Lifting hazard!

Failure to lift the unit correctly can cause injury and/or property damage

7. Storing / Remove from use

In order to prevent damage to the refrigeration air dryer during storage, the following conditions must be provided:

- The dryer should only be stored in a dry and enclosed space.
- During storage, the ambient temperature must be within the temperature range of 1 ° C to 45 ° C. Contact the manufacturer / supplier for other storage temperatures.
- Make sure the refrigeration air dryer input and output are sealed.

In case you intend to store a dryer that has already been used, follow the instructions below:

- Turn off the dryer.
- Disconnect the power supply.
- Disconnect the refrigeration air dryer from the air connection.
- Disconnect the pipe connections.
- Seal the input and output of the dryer.
- Clean the front of the condenser
- Cover the dryer to protect it from dust.

8. Installation

8.1. General environment requirements

The following location requirements must be met for the dryer to operate properly:

- Clean and dry space protected against atmospheric conditions.
- The installation area must be even and able to bear the weight of the dryer.
- The minimum ambient temperature is +1,5 ° C
- The maximum ambient temperature is +45 ° C
- Ensure adequate ventilation to cool the device
- Installation without vibration (refers to the floor and pipes)
- For maintenance and servicing, provide sufficient space for uninhibited work around the unit (1 m).



Caution!

Ambient conditions!

Never expose the dryer to explosive gases, high heat, extreme dust and/or corrosive environment.

Never obstruct the ventilation grilles.

Draught could have a negative impact on the performance of the dryer.

Installing the dryer in the environment which does not meet the general requirements can cause a loss of efficiency and performance of the dryer and in some cases to breakdown of the dryer.

8.2. Compressed air quality and connection

Standard configuration of the dryer does not include prefilter. Prefilter (3 µm) has to be installed upstream of the dryer.

The compressed air supplied to the refrigeration air dryer must comply with ISO 8573-1. class 2.

The temperature of the compressed air must not exceed 55 °C. In case the temperature is higher, aftercooler must be installed between compressor and refrigeration dryer.

The supplied compressed air must not make high pressure fluctuation. Install compressed air receiver to avoid pulsations.

Piping connection to dryer inlet and outlet has to be removable. It is recommended to provide bypass piping to make maintenance possible.

Piping and fittings must be selected according to the operating pressure, temperature and flow rate of the dryer.

Piping must be clean, free from dust, iron rust and other particles.



Caution!

Contaminated compressed air!

Contaminated air can reduce refrigeration dryer efficiency and performance. In worst case it can clog the heat exchanger and permanently damage the dryer.

8.3. Electrical connection

Adequate power supply needs to be provided. See the data plate on the dryer. Voltage tolerance is $\pm 10\%$ It is mandatory for the dryer to be grounded. Plug the power cord into a grounded (earthed) electrical outlet that is easily accessible at all times.

The installer is responsible to provide proper fuse(s) and ground fault circuit breaker.



Danger!

High voltage!

Do not route the power cord where it can be walked on or pinched by items placed against it. Never connect the dryer to mains with damaged power cord.

8.4. Installation arrangement

Two most common installation arrangements of the refrigeration dryer are presented in Figure 8 Installation arrangements. They are not mandatory and are presented just as sample. A different arrangement of components is always possible.

Type A installation is recommended when the compressor operates at a reduced interruption rate and total consumption that equals the flow of the compressor.

Type B installation is recommended when air consumption is usually repeated with conical values that are much higher than the compressor flow. The capacity of the pressure vessel must be dimensioned according to possible instantaneous needs (peak consumption).

Air dryer is designed to adapt to different compressed air loads. Even though the dryer adapts to changes in the air flow quit quickly it cannot adapt immediately. It is recommended to install compressed air receiver to avoid quick changes in the compressed air flow.

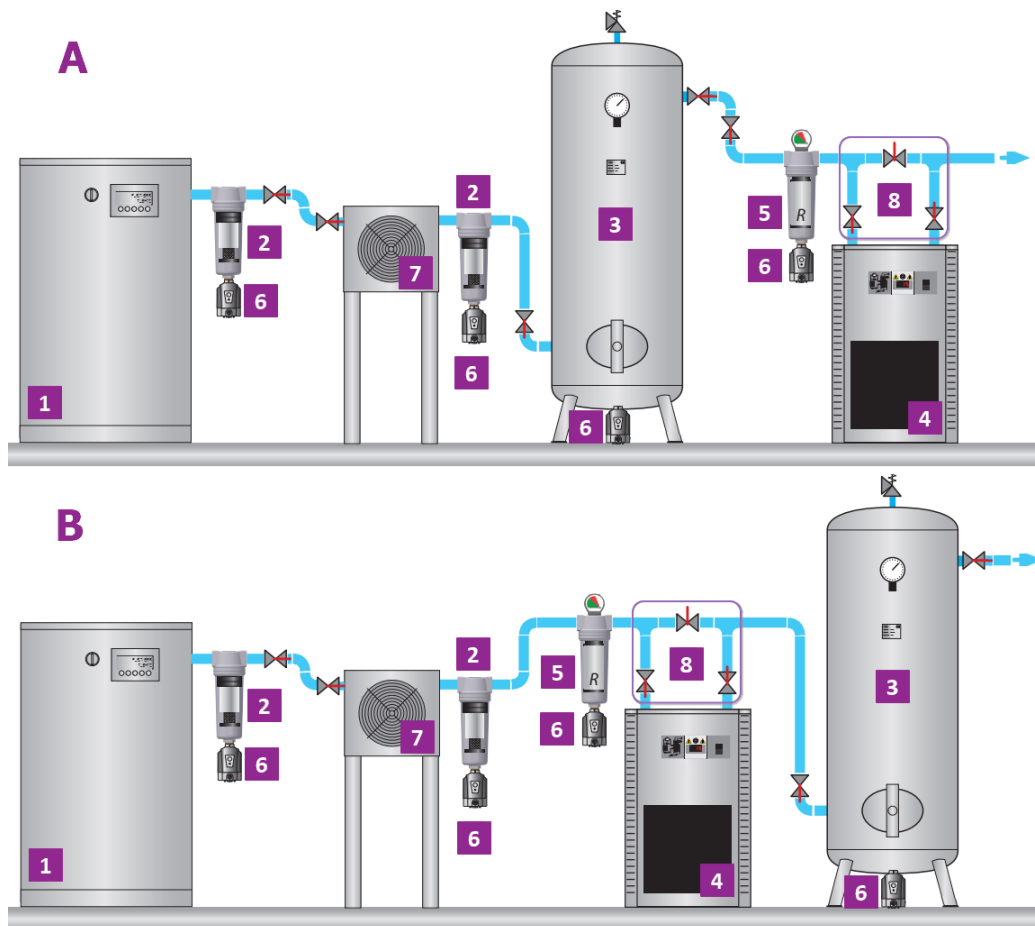

Figure 8 Installation arrangements

- | | |
|---------------------------|-------------------------------|
| 1. Compressor | 5. Pre-filter (min. 5 micron) |
| 2. Condensate separator | 6. Condensate drain |
| 3. Pressure vessel | 7. Aftercooler |
| 4. Refrigerated air dryer | 8. Bypass air valves |

8.4. Installation procedure

- The refrigeration air dryer is typically delivered on the standard pallet on which it is screwed with four screws.
- The refrigeration air dryer can be lifted with forklift trucks.
- Remove the screws and the pallet before positioning the dryer at the desired location.
- The refrigeration air dryer should be installed in such a way that it is protected from weather (for example, a compressor station).
- It is recommended to have 1 m of space around the dryer. This measure facilitates maintenance.
- Make sure that the dryer is protected against vibration and mechanical wear.
- The dryer must stand firmly on a horizontal basis. The tilt of the unit must not exceed $\pm 3^\circ$. The best way to achieve these conditions is to fasten the dryer with screws onto a horizontal base through the appropriate openings on the base. If the dryer is not installed properly, there may be improper operation. Fastening the dryer with screws is not obligatory.
- 20 - 235 drier models can be attached to the wall with wall screws - the position of the holes in the illustration is shown. (maximum size M8)
- The pipe connections for the compressed air in the front and back of the dryer must be fitted with suitable valves that allow the independent installation or removal of the dryer from the system.
- Install a super fine coalescent filter on the input side and pre-filter on the output side. It only applies if the dryer has no built-in filters.
- Check that the air is properly treated before the dryer (air conveyor, cyclone separator, filters, condensate separators ...).
- Remove the plastic covers from the dryer's input and output.
- Connect the air source to the dryer.
- The temperature and flow of the intake air into the refrigeration air dryer must remain within the limit values indicated on the data plate of the device.
- The pipelines of the system must be free of dust, rust, filings and other impurities and must correspond to the flow of the dryer.
- It is also recommended that you arrange an air bypass line.
- Connect the dryer to the power source. Ensure that the supply voltage and the frequency correspond to the data on the type label ($\pm 5\%$ acceptable tolerance for the supply voltage).
- Remove the packaging and other material that could hinder the dryer during normal operation.

9. Start-up and shut down

9.1. Before start-up

This dryer has been fully tested, packaged and checked before shipping. Nevertheless, it may happen that it is damaged during transport. Before starting it up for the first time, check its compliance, and for the first few hours of operation, you should also carefully monitor its behavior.

Before start-up, check that the operating parameters correspond to the nominal values indicated on the data label of the dryer (frequency, air pressure, air temperature, ambient temperature, ...).

- Ensure that the connections (in and out) to the compressed air system are correct and tightened.
- Ensure that the power supply is correct as required on the data plate.
- Ensure that the condensate piping is properly secured and connected to the collection system or collector. Condensate drain service valve must be opened if installed.
- Ensure that ventilation grilles are not blocked even partly.
- Ensure that the bypass air circuit is closed and that the dryer is insulated from the system.
- Check and ensure that the condenser is clean, free of impurities.





Notice!

It is recommended to wait 3 - 6 hours after the dryer was first installed or moved from another location. Turn the main power switch ON and leave the dryer in standby mode.

Do not start the dryer more than 6 times/hour.

9.2. Start-up



- Slowly open the inlet valve to pressurize the system – opening the valve quickly can damage the dryer.
- Move the main power switch to ON
- If “OFF” is displayed on the controller press  +  for 3 seconds to start the dryer.
- Wait few minutes for dew point to stabilize.
- Slowly open the outlet valve to supply the dry compressed air to the system and close central bypass valve, if installed.



Notice!

Check the piping and fittings immediately after start up and after one month after installation for possible leaks.

9.3. Shut down

- Press  +  to put the dryer in the standby mode.
- Move the main power switch to OFF.
- For long term shut down please check chapter 7. Storing / Remove from use

10. Maintenance

During the maintenance work on the refrigeration air dryer, turn it off and wait for at least 30 minutes for it to cool down. Some components can reach high temperature during operation. Avoid contact with these components until they completely cool down.

Daily check that the dew point shown on the controller is appropriate. Also check the correct operation of the condensate drainage system. In case of impurities on the condenser, clean it.

Monthly or every 200 hours blow out and clean the condenser with an air jet from the inside to the outside. Repeat the procedure from the opposite direction, making sure that you do not damage the aluminum ribs of the condenser. Check the condensate drainage function. Finally check the operation of the device.

Annually or every 1000 hours check for potential coolant leakage points. Measure and record the power consumption. Ensure that the measured values are within the limit values recorded in these instructions. Finally check the operation of the device.

Every 8000 hours replace the electronic condensate drainage unit. (Service kit)

11. Dismantling / disposal of the dryer

When the dryer is dismantled or disposed all parts need to be disposed separately based on your local directives and provisions. Check chapter 3.2. Specifications for materials used.



Caution!
Refrigerant!

Refrigerant must not be discharged into environment. All the refrigerant has to be collected for further use or disposal at the collection point.

12. Troubleshooting







Danger!





Troubleshooting and maintenance procedures can only be performed by qualified personnel with the necessary knowledge.

Before any maintenance or service parts make sure that:

- no part or device is powered and must not be connected to a power source
- that no part or device is under pressure and must not be connected to a compressed air system under pressure,
- that the maintenance staff fully and accurately read the operating instructions, and in particular the chapters relating to safety at work.

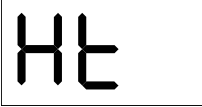
SYMPTOM	POSSIBLE CAUSE	PROPOSED ACTIONS
The dryer does not start	"OFF" is displayed on the controller	Press  +  for 3 seconds to start the dryer.
	Controller display does not show anything, all LEDs are off.	Check the power supply and electrical installation (external and internal).
	Alarm LED is on, controller shows alarm message	Alarm was triggered more than 5 times in 24 hours. Remove the cause for alarm and reset the dryer. Check chapter 5.4. Controller for additional information.
	The controller shows anything else what is not described in chapter 5.4. Controller .	The controller is broken, contact supplier/manufacturer, replace the controller
The compressor does not work	Activated internal thermal protection of the compressor.	Wait 30 min and then start the dryer again.
	No electrical power	If installed check high pressure sensor If installed check low pressure sensor Check the electrical installation.
	Controller in alarm condition	Check chapter 5.4. Controller for additional information.
The condenser fan does not work	Condensing pressure is low	Wait for condensing pressure to rise. Fan will start automatically.
	No electrical power	Check the electrical installation Replace the controller Replace the fan
	Refrigerant leakage	Get in touch with an engineer in the field of refrigeration.

SYMPTOM	POSSIBLE CAUSE	PROPOSED ACTIONS
Excessive pressure drop	Condensate not drained	Check the corresponding point
	Low dew point (condensate is freezing inside the evaporator and obstruct the air flow)	Check the corresponding point
	Piping connections and valves	Check the piping connections and valves
Dew point is too high (> 10 °C) or 	Air dryer does not work	Check the dryer status (standby mode, alarm, power...)
	Controller readings are wrong	Replace the dew point temperature sensor. Replace the controller
	Refrigeration compressor does not operate	Check the corresponding point
	High ambient temperature	Assure nominal operating conditions
	High compressed air inlet temperature	
	Low inlet pressure	
	Compressed air flow too high	
	Dirty condenser	Clean the condenser (see 10. Maintenance)
	Obstructed fan grilles	Remove obstruction
	Fan does not work	Check the corresponding point
	Refrigerant leakage	Get in touch with an engineer in the field of refrigeration.
Condensate not drained	Check the corresponding point	
Dew point is too low (< 0 °C) or 	Fan always on	Replace the controller
	Ambient temperature too low	Assure nominal operating conditions
Condensate not drained	Condensate drain not working	Check the condensate drain power supply. Clean the condensate drain. Replace the condensate drain.
	Low dew point (condensate is freezing inside the evaporator and obstruct the air flow)	Check the corresponding point.
There's water in the pipeline	The dryer does not start	Turn on the dryer
	Compressed air bypass valve is opened (if installed)	Check the compressed air bypass valve.
	Reversed input and output of the compressed air	Check the dryer is properly connected to the compressed air line.

SYMPTOM	POSSIBLE CAUSE	PROPOSED ACTIONS
High compressor discharge temperature or 	Thermal overload	Assure nominal operating conditions
	Ambient temperature too high	
	Inlet temperature too high	
	The condenser is dirty	Check the corresponding point
	The fan does not work	
	Refrigerant leakage	Get in touch with an engineer in the field of refrigeration.
	Controller temperature readings are wrong	Replace the compressor temperature sensor. Replace the controller.
Errors "Pf1", "Pf2", "Pf3" are shown on controller Dew point:  Compressor:  Condenser: 	A sensor is missing or is badly/incorrectly installed	Check the corresponding sensor wiring Replace the corresponding sensor
	Faulty controller	Controller has to be replaced



Notice!

In case support from supplier / manufacturer is needed please prepare the problem description and at least the following data:

- Type / model of the dryer
- Serial number
- Controller status (alarm, dew point value shown)
- Compressor temperature (Press ▲)
- Relative fan speed (Press ▼)

13. Warranty

The warranty is valid for 12 months from the date of purchase and no more than 14 months from the date of dispatch.

During this time, the parts that were originally incomplete will be repaired or replaced free of charge. This does not include travel costs, accommodation and food for our technicians.

The guarantee excludes any possible direct or indirect damage to people, animals or property resulting from improper use or inadequate maintenance of the device, and is limited solely to production errors. When claiming a warranty, you must provide information from the identification label.

Warranty is void if:

1. The instructions were not followed for installation and maintenance
2. The unit was not used according to the instructions.
3. The unit operated even though the improper operation was apparent.
4. Non-original parts were used.
5. The unit did not work within the allowed technical parameters.
6. Unauthorized structural changes were made on the unit or parts thereof.
7. Data plate is missing.

Warranty specifically excludes damages due to incorrect installation, unauthorized modification, lack of maintenance, corrosion and operating the equipment outside the design limits.

Warranty will cover only parts and labour.

Always consult your supplier or manufacturer before any intervention on the dryer.

14. Spare parts

For the correct spare parts list contact your supplier/manufacturer.



Notice!

Always provide the information from data plate when ordering the spare parts.

15. Drawings

For the correct drawings list contact your supplier/manufacturer.

16. Electric diagram

For the correct spare parts list contact your supplier/manufacturer.

17. Maintenance notes

MAINTENANCE TYPE	DATE	SIGNATURE	NOTES
First installation			

MAINTENANCE TYPE	DATE	SIGNATURE	NOTES





EC Declaration of Conformity

Omega Air d.o.o. Ljubljana
Cesta Dolomitskega odreda 10
1000 Ljubljana
Slovenia

Declares that

Product: Refrigeration dryer

Model: RDP 20, RDP 35, RDP 50, RDP 75, RDP 100, RDP 140, RDP 180, RDP 235, RDP 300, RDP 380, RDP 480, RDP 600, RDP 750, RDP 950, RDP 1150, RDP 1300, RDP 1500, RDP 1900, RDP 2600, RDP 3400, RDP 4400, RDP 5400, RDP 6600, RDP 7200, RDP 8800, RDP 10800, RDP 13200

Description: Compressed air refrigeration dryer

Is in conformity with the following directives:

Machinery directive 2006/42/EU

ISO 12100:2010,
ISO 13857:2019

Pressure Equipment Directive (PED) 2014/68/EU

Electromagnetic Compatibility Directive (EMC) 2014/30/EU

EN 61000-6-3:2021
EN 61000-6-2:2019,
EN 61000-3-2:2019,
EN 61000-3-3:2014/A1:2019

Low Voltage Directive (LVD) 2016/35/EU

Our quality management system is certified by BUREAU VERITAS in conformity with ISO 9001:2015



A.Dobnikar
Technical manager

Date of issue 31. 07. 2024





EC Declaration of Conformity

Omega Air d.o.o. Ljubljana
Cesta Dolomitskega odreda 10
1000 Ljubljana
Slovenia

Declares that

Product: Refrigeration dryer

Model: RDT 20, RDT 35, RDT 50, RDT 75, RDT 100, RDT 140, RDT 180, RDT 235, RDT 300, RDT 380, RDT 480, RDT 600, RDT 750, RDT 950, RDT 1150, RDT 1300, RDT 1500, RDT 1900

Description: Compressed air refrigeration dryer

Is in conformity with the following directives:

Machinery directive 2006/42/EU

ISO 12100:2010,

ISO 13857:2019

Pressure Equipment Directive (PED) 2014/68/EU

Electromagnetic Compatibility Directive (EMC) 2014/30/EU

EN 61000-6-3:2021

EN 61000-6-2:2019,

EN 61000-3-2:2019,

EN 61000-3-3:2014/A1:2019

Low Voltage Directive (LVD) 2016/35/EU

Our quality management system is certified by BUREAU VERITAS in conformity with ISO 9001:2015



A.Dobnikar
Technical manager

Date of issue 31. 07. 2024

OMEGA AIR d.o.o. Ljubljana

Cesta Dolomitskega odreda 10

1000 Ljubljana, Slovenia

T: +386 (0)1 200 68 00

info@omega-air.si

www.omega-air.si



OMEGA AIR